

WATERSTOP-RX®

EXPANDING CONCRETE JOINT WATERSTOP

DESCRIPTION

WATERSTOP-RX® is a hydrophilic strip waterstop designed to stop water infiltration through cast-in-place concrete construction joints by expanding upon contact with water to form a positive seal against the concrete. The key to WATERSTOP-RX®'s effectiveness is its superior expansion to seal and fill voids and cracks in the concrete. WATERSTOP-RX® is an active waterstop that is designed to replace passive PVC/Rubber dumbbell waterstops, thereby eliminating the requirement of special pieces, split-forming and seam welding. WATERSTOP-RX® has been successfully tested by independent testing firms to over 60 meters of hydrostatic water pressure, under both continuous immersion and wet/dry cycling.

WATERSTOP-RX® is available in two sizes (see Product Table). WATERSTOP-RX® 101 is produced in a rectangular shape measuring 25 x 19 mm. WATERSTOP-RX® 103 is produced in a rectangular shape measuring 15 x 10 mm.

Though WATERSTOP-RX® possesses good resistance to many chemicals, the waterstop is not intended to be used as the primary joint sealant for chemical containment vessels. Consult manufacturer for guidance regarding chemical compatibility for secondary chemical containment applications. Additionally, WATERSTOP-RX® is not an expansion joint sealant; contact CETCO for expansion joint applications.

APPLICATIONS

Applications include both vertical and horizontal non-moving concrete construction joints, new to existing concrete construction, irregular surfaces, and around through-wall penetrations, such as plumbing and utility pipes. Additionally WATERSTOP-RX® can seal around penetrations, concrete pilings and steel H-piles passing through the slab. WATERSTOP-RX® works in both continuous hydrostatic and intermittent hydrostatic conditions.

WATERSTOP-RX® products are designed for reinforced structural concrete with a minimum of 20 N/mm² compressive strength. RX-101 is designed for concrete 200 mm thick or great-

er with two rows of reinforcing steel. RX-103 is designed for vertical concrete 150 mm thick or greater; and horizontal concrete no less than 100 mm thick. RX-103 should be used in concrete with one row of steel reinforcement, concrete curbs, planter walls, fountains, and lightweight structural concrete.

WATERSTOP-RX® is a reliable, cost-effective means to stop water infiltration through concrete construction joints. It can also be used around pipe and structural penetrations

INSTALLATION

Surface preparation: Surfaces should be clean and dry. Remove all dirt, rocks, rust or other construction debris. Do not install WATERSTOP-RX® in standing water or on an iced substrate.

Adhesive: Apply a continuous bead of CETSEAL along the substrate where WATERSTOP-RX® will be installed. Assure minimum 75 mm concrete coverage will be maintained (50 mm for RX-103). Keep the nozzle tip pressed against the concrete at a 45° angle during application.

Installation: After applying a continuous bead of CETSEAL, remove release paper, then firmly press the entire length of WATERSTOP-RX® onto the adhesive. For vertical and overhead applications, firmly press a minimum of 15 seconds to assure adhesion. For best results apply WATERSTOP-RX® within 15 minutes of adhesive installation. WATERSTOP must be placed into adhesive prior to CETSEAL skinning over and curing. CETSEAL may be applied to damp surfaces, but not in standing water.

Tightly butt coil ends together to form a continuous WATERSTOP – do not overlap coil ends. Place in maximum practical lengths to minimize coil end joints. Where required, cut coils with a sharp knife or utility blade to fit coil ends together. Make horizontal to vertical transitions by abutting product coil sections together, no special accessory pieces are required.

At structural and pipe penetrations, cut into strips to fit around the penetration. Apply to adhesive and abut coil ends together.

On irregular surfaces such as stone or rough concrete, make sure WATERSTOP-RX remains in direct contact with the substrate along the entire installation. There should not be any air gap between the WATERSTOP-RX and the substrate.

Installation with REVO-FIX: REVO-FIX is a steel mesh used to mechanically secure WATERSTOP-RX® into position using the accompanying supplied fixings. REVO-FIX is available in two sizes; REVO-FIX 101 (for securing WATERSTOP-RX® 101) and REVO-FIX 103 (for securing WATERSTOP-RX® 103).

Remove release paper and place the WATERSTOP-RX on the concrete substrate. Then place REVO-FIX strips over the WATERSTOP-RX, lapping the strip ends by 25 mm maximum. Nail through lap with fixings supplied, and install one fixing 300 mm c/c along the REVO-FIX. End-to-end or end-to-side REVO-FIX junctions are created by simple but joints pressed firmly together. Start at junctions; do not stretch WATERSTOP-RX to fit. Do not overlap WATERSTOP-RX.

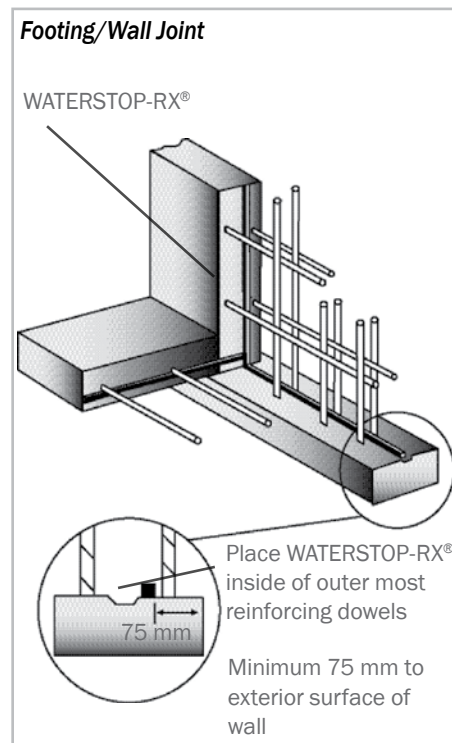

General Application Detail

WATERSTOP-RX® EXPANDING CONCRETE JOINT WATERSTOP

LIMITATIONS

WATERSTOP-RX® is not a self-adhering product. Either CETSEAL or REVO-FIX are required to secure WATERSTOP-RX® to concrete. CETSEAL is required to secure WATERSTOP-RX® to metal or PVC (pipe) surfaces. Mechanical fixings should be used with REVO-FIX to secure WATERSTOP-RX; and fixings can be used in conjunction with CETSEAL. Mechanical fixings should not be used to secure WATERSTOP-RX alone. Do not use any other adhesive or construction sealant apart from CETSEAL to secure WATERSTOP-RX®.

WATERSTOP-RX® is not designed, nor intended to function as an expansion joint sealant. For precast concrete applications, contact manufacturer for product suitability and for any special installation requirements.

WATERSTOP-RX® products are designed for structural concrete with a minimum of

20 N/mm² compressive strength. WATERSTOP-RX® 101 requires a minimum of 75 mm of concrete coverage. WATERSTOP-RX® 103 requires a minimum concrete coverage of 50 mm. WATERSTOP-RX® should only be used in applications where the product is completely encapsulated within the concrete.

WATERSTOP-RX® should not be prehydrated by being subjected to submersion or remain in extended contact with water prior to encapsulation in concrete. If the product exhibits considerable swell prior to encapsulation in the concrete, it must be replaced with new material.

In conditions where severe ground water chemical contamination exists, or is expected, consult manufacturer for product chemical compatibility information.

PACKAGING

RX-101: 30 m per box
RX-103: 48 m per box
CETSEAL and REVO-FIX are packaged separately.

ACCESSORY PRODUCTS

CETSEAL is a multi-purpose, single component polyether moisture cure adhesive used to secure WATERSTOP-RX® into position. Apply a continuous bead of CETSEAL to substrate then install WATERSTOP-RX® before CETSEAL skins over and cures. Adhesive yield will vary with use, substrate and application.

WATERSTOP-RX® PRODUCT TABLE

PRODUCT	SIZE	ROLL LENGTH	CROSS-SECTION SHAPE	UNIT QTY/CARTON	MIN CONCRETE COVERAGE
RX-101	25 mm x 19 mm	5 m	Rectangle	30 m	75 mm
RX-103	15 mm x 10 mm	6 m	Rectangle	48 m	50 mm

WATERSTOP-RX® EXPANDING CONCRETE JOINT WATERSTOP

5 FAST & EASY INSTALLATION STEPS

STEP 1

CLEAN SURFACE

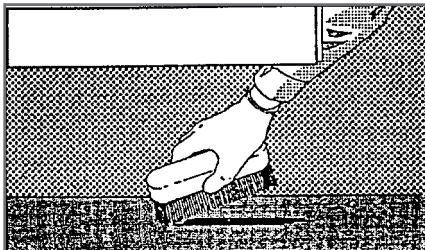

REMOVE ALL DIRT AND DEBRIS

STEP 2

APPLY ADHESIVE

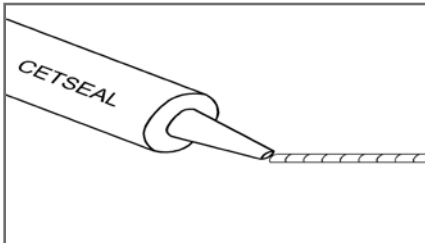

APPLY CETSEAL

STEP 3

PLACE WATERSTOP

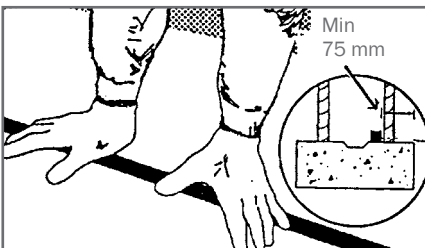

REMOVE RELEASE PAPER THEN PRESS FIRMLY AGAINST CETSEAL. MAINTAIN MIN. CONCRETE COVERAGE DEPTH

STEP 4

BUTT COIL ENDS

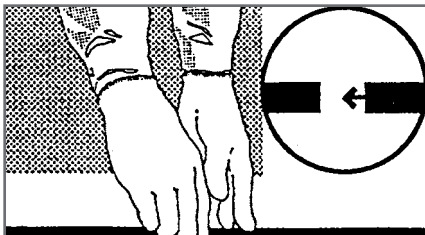

TIGHTLY BUTT COIL ENDS TO FORM A CONTINUOUS WATERSTOP. DO NOT OVERLAP COIL ENDS

STEP 5

POUR CONCRETE

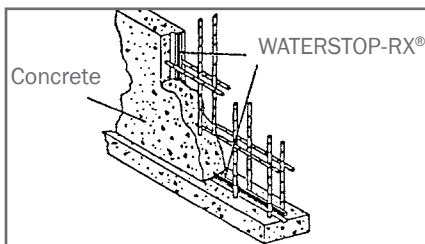

LIMITED WARRANTY

Specifications and other information contained herein supersedes all previously printed matter and are subject to change without notice.

All goods sold by seller are warranted to be free from defects in material and workmanship. The foregoing warranty is in lieu of and excludes all other warranties not expressly set forth herein, whether expressed or implied by operation of law or otherwise, including but not limited to any implied warranties of merchantability or fitness.

Seller shall not be liable for incidental or consequential losses, damages or expenses, directly or indirectly arising for the sale, handling or use of goods, or from any other case relating thereto, and seller's liability hereunder in any case is expressly limited to the replacement (in the form originally shipped) of goods not complying with the agreement or at seller's election, to the repayment of, or crediting buyer with, an amount equal to the purchase price of such goods, whether such claims are for breach of warranty or negligence.

Any claim by buyer with reference to the goods sold hereunder for any cause shall be deemed waived by buyer unless submitted to seller in writing within thirty (30) days from the date buyer discovered or should of discovered, any claimed breach.

Materials should be inspected and tested by purchaser prior to their use if product quality is subject to verification after shipment. Performance guarantees are normally supplied by the applicator.

TYPICAL PROPERTIES

PROPERTY	TEST METHOD	VALUE
Hydrostatic Head Resistance	Independent Test	70 m
Wet / Dry Cycling (25 Cycles @ 70 m)	Independent Test	No Effect
Adhesion to Concrete Using CETSEAL	Independent Test	Excellent

WATERSTOP-RX® EXPANDING CONCRETE JOINT WATERSTOP

TYPICAL PRODUCT APPLICATIONS

WATERSTOP-RX® 101

- Vertical and horizontal concrete 200 mm thick or greater
- Concrete with two rows of steel reinforcement
- Shotcrete Foundation Walls
- High hydrostatic pressures
- Tie-back plates and penetrations

WATERSTOP-RX® 103

- Vertical concrete 150 mm thick or greater.
- Horizontal concrete 100 mm thick or greater
- Concrete with one row of steel reinforcement
- Slabs containing only wire mesh
- Fountains / Planter Boxes / Curbs
- Penetrations

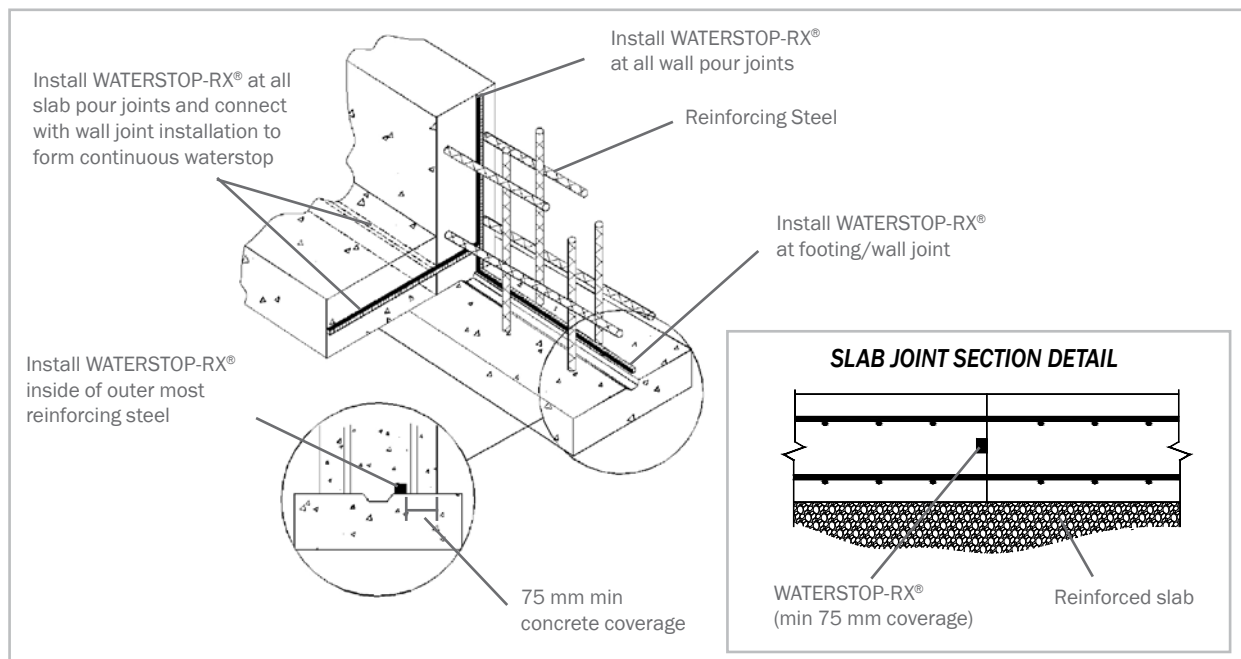

Typical WATERSTOP-RX® Foundation Detailing

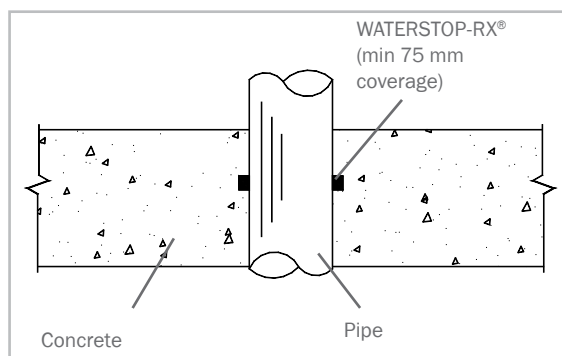

Cast-in-Place Penetration

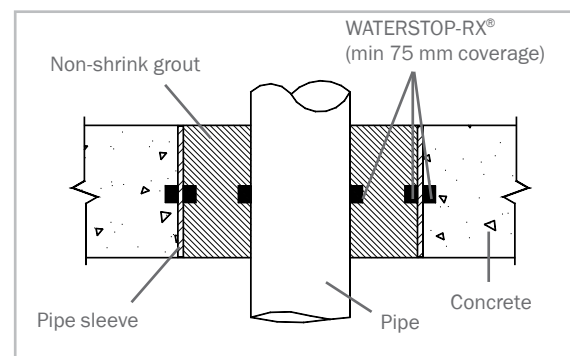

Sleeved Penetration Detail

